

Team Strike Evo

Iconic (R)evolution



sitland



The new Team Strike Era

There is no evolution without change.

The **EVO** version, designed by **Zakaria Khalfaoui**, is the new reinterpretation in a more sustainable key, of our most famous task chair Team Strike. Maintaining the iconic structure of the backrest and preferring the use of recycled materials, we have worked on the integration of the mechanism and on a more minimal design.

IT

Non esiste evoluzione senza cambiamento.

La versione **Evo** è la nuova reinterpretazione in chiave più sostenibile, firmata da **Zakaria Khalfaoui**, della nostra sedia operativa più famosa: Team Strike. Mantenendo la struttura iconica dello schienale e prediligendo l'utilizzo di materiali riciclati, abbiamo lavorato sull'integrazione dei meccanismi e su un design più minimale.

FR

Il n'y a pas d'évolution sans changement.

La version **Evo** est la nouvelle interprétation de Team Strike notre plus célèbre fauteuil de travail, dans un esprit plus durable et conçue par **Zakaria Khalfaoui**. Tout en conservant la structure iconique du dossier et en privilégiant l'utilisation de matériaux recyclés, nous avons travaillé sur l'intégration de mécanismes et un design plus minimaliste.

DE

Es gibt keine Evolution ohne Veränderung

Die **EVO**-Version, entworfen von **Zakaria Khalfaoui**, ist die neue Neuinterpretation unseres berühmtesten Arbeitsstuhls Team Strike in einem nachhaltigeren Stil. Unter Beibehaltung der ikonischen Struktur der Rückenlehne und der bevorzugten Verwendung von recycelten Materialien haben wir an der Integration der Mechanismus und einem minimalistischeren Design gearbeitet.

ES

No hay evolución sin cambio.

La versión **Evo** es la nueva reinterpretación en clave más sostenible, diseñada por **Zakaria Khalfaoui**, de nuestra silla operativa más famosa: Team Strike. Manteniendo la estructura icónica del respaldo y privilegiando el uso de materiales reciclados, hemos trabajado en la integración de los mecanismos y en un diseño más minimalista.



Evo as Evolution!

New features that make the difference

- 1**
Backrest in mesh or fabric
- 2**
Backrest structure in recycled plastic
- 3**
New armrests
- 4**
Seat upholstery removable, applied without the use of glue
- 5**
New mechanism integrated in the seat
- 6**
New nylon base with recycled plastics
- 7**
Black or white finishes



IT

1. Schienale in rete o tessuto
2. Struttura schienale con plastiche riciclate
3. Nuovi braccioli
4. Rivestimento sfoderabile, applicato senza colla
5. Design minimale del sedile e meccanismo integrato
6. Nuova base in nylon con plastiche riciclate
7. Finiture disponibili in colore bianco o nero

FR

1. Revêtue en maille ou en tissu
2. Structure du dossier en plastique recyclé
3. Nouveaux accoudoirs
4. Revêtement amovible appliqué sans colle
5. Nouvelle mécanique intégrée au siège
6. Nouvelle base en nylon avec des plastiques recyclés
7. Finitions disponibles en blanc ou noir

DE

1. Netz- oder Stoffbezug
2. Rückenlehnenstruktur aus recyceltem Kunststoff
3. Neue Armlehnen
4. Abnehmbarer Sitzbezug, ohne Klebstoff angebracht
5. Neue Synchronmechanik
6. Neue Nylonbasis mit recycelten Kunststoffen
7. Ausführungen in Weiß oder Schwarz erhältlich

ES

1. Tapizado de malla o tela
2. Estructura del respaldo con plásticos reciclados
3. Nuevos brazos
4. Tapicería extraíble aplicada sin el uso de pegamento
5. Nueva mecánica integrada en el asiento
6. Nueva base de nailon con plásticos reciclados
7. Acabados disponibles en blanco o negro



(R)Evolution of spaces

**Whether it's co-working or a single workstation,
Team Strike Evo has the ability to integrate
easily into any context.**

The right task chair for every space is finally here!
The new design of Team Strike Evo adapts perfectly to any work environment,
from open spaces to single offices, passing through the home office.

IT

**Sia che si tratti di co-working o di una postazione
di lavoro singola, Team Strike Evo ha la capacità
di integrarsi facilmente in qualsiasi contesto.**

La sedia operativa giusta per ogni spazio
è finalmente arrivata!
Il nuovo design di Team Strike Evo si adatta
perfettamente a qualsiasi ambiente di lavoro,
dagli open space, agli uffici singoli,
passando per l'home office.

FR

**Team Strike Evo a la capacité de s'intégrer
facilement dans n'importe quel contexte,
co-working ou poste de travail individuel.**

Le bon siège de travail pour chaque espace est
enfin arrivé! Le nouveau design du Team Strike Evo
s'adapte parfaitement à tout environnement
de travail, des espaces ouverts, aux bureaux
individuels et aux bureaux à domicile.

DE

**Ob Co-Working oder Einzelarbeitsplatz,
Team Strike Evo lässt sich problemlos
in jeden Kontext integrieren.**

Endlich ist der richtige Drehstuhl für jeden Raum da!
Das neue Design von Team Strike Evo
passt sich perfekt an jede Arbeitsumgebung an,
von Open Spaces bis hin zu Einzelbüros,
die durch das Home Office gehen.

ES

**Ya sea en un entorno de trabajo conjunto
o en un único puesto de trabajo,
Team Strike Evo tiene la capacidad de integrarse
fácilmente en cualquier contexto.**

Por fin ha llegado la silla de trabajo adecuada
para cada espacio. El nuevo diseño de Team Strike
Evo encaja perfectamente en cualquier entorno
de trabajo, desde espacios abiertos hasta despachos
individuales y oficinas en casa.









The same iconic design with a sustainable approach.





76%
Recyclable
at the end of life



100%
Disassembled



100%
Repairable



37%
Recycled
materials



86%
Nearby Suppliers
within 130 km

Materials			Recycled Materials		Recyclable Materials		
	Weight	% Weight	Weight	% Weight	Weight	% Weight	
Metals							14%
Aluminum	1,94 kg	13,86%	0,58 kg	30,06%	1,94 kg	100%	
Plastics							30%
Polyamide 6.6 (Pa66) + 15% fb	0,08 kg	0,57%	0 kg	0%	0,08 kg	100%	
Polyamide 6.6 (Pa66) + 30% fb	2,55 kg	18,21%	1,42 kg	55,69%	2,55 kg	100%	
Polyurethane foam	0,87 kg	6,21%	0 kg	0%	0 kg	0%	
Polyester fabric	0,20 kg	1,43%	0,20 kg	100%	0 kg	0%	
Polypropylene	0,51 kg	3,64%	0,46 kg	90,20%	0,51 kg	100%	
Other materials							56%
Mixed materials (metal + plastic)	7,85 kg	56,07%	2,53 kg	32,23%	5,5 kg	70,06%	
Total weight (Without packaging)	14,00 kg	100%	5,19 kg	37,09%	10,58 kg	75,57%	100%

Data based on Team Strike Evo task chair, with base and structure in black plastic, backrest and seat in fabric, no armrest.

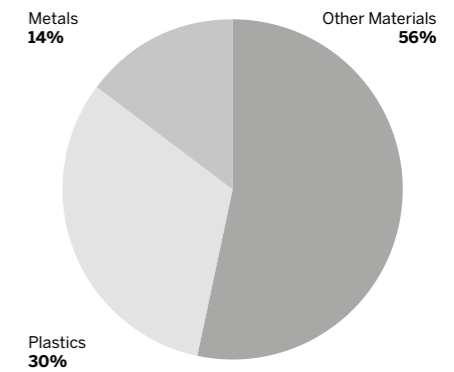

Technical data

1. Headrest in flexible cold injected polyurethane foam, height adjustable.
2. Back structure in polyamide with upholstery in mesh or fabric.
Back support in die-cast aluminium with polish or paint finish. Height adjustable lumbar support
3. 2D or 4D armrests with soft-touch TPU top
4. Seat depth adjustment with self adjustable synchro mechanism according to the user's body weight.
Ergonomic seat in cold injected polyurethane foam, fire retardant.



IT

1. Poggiatesta con cuscino in poliuretano morbido, regolabile in altezza.
2. Schienale con struttura in poliammide con rivestimento in rete o tessuto. Supporto schienale in alluminio pressofuso con finitura lucida o verniciata.
Supporto lombare regolabile in altezza.
3. Braccioli 2D o 4D con top in TPU soft-touch
4. Sedile con regolazione di profondità e meccanismo sincronizzato autop pesante. Imbottitura sedile ignifuga in poliuretano flessibile schiumato a freddo.

FR

1. Tête avec coussin en polyuréthane souple, réglable en hauteur
2. Dossier avec structure en polyamide et revêtement maille ou tissu. Support de dossier en aluminium moulé sous pression et finition polie ou vernie.
Support lombaire réglable en hauteur
3. Accoudoirs 2D ou 4D avec dessus TPU soft-touch
4. Réglage de l'assise en profondeur avec mécanisme autorégulé synchronisé. Assise rembourrée en mousse de polyuréthane ignifugée moulée à froid.





















DE

1. Kopfstütze mit Kissen aus weichem Polyurethan in Schwarz, Höhenverstellung
2. Rückenlehnenrahmen aus Polyamid mit Netzbezug oder Stoffbezug. Rückenlehnhalterung aus Aluminium-Druckguss mit polierter oder lackierter Oberfläche. Höhenverstellbare Lumbalstütze
3. 2D- oder 4D-Armlehnen mit Soft-Touch-TPU-Oberfläche
4. Schiebesitz und Synchronmechanik mit automatischer Gewichtsregulierung und Einstellung der Schwingung. Sitzpolsterung aus Polyurethan-Kaltschaumstoff, schwer entflammbar.

ES

1. Reposacabezas en espuma flexible de poliuretano inyectado en frío, altura ajustable
2. Estructura trasera en poliamida con tapizado de malla o tela. Soporte trasero en aluminio fundido a presión con acabado pulido o pintado. Soporte lumbar ajustable en altura
3. Brazos 2D o 4D con parte superior de TPU suave al tacto
4. Ajuste de profundidad del asiento con mecanismo de sincronización autoajustable según el peso corporal del usuario. Asiento ergonómico en espuma de poliuretano inyectada en frío, ignífugo.

Finish and options

		
Back structure		
Back support		 
Base	 	 
Back and seat upholstery	 	 
Armrest		
Headrest pad		
Lumbar support		

Certifications



D.Lgs. 81/08



1 IM CLASS

Dimensions

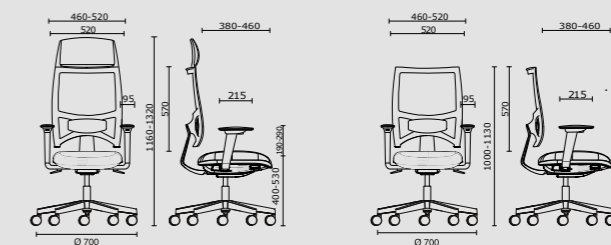

EN-1335-1:2020
TYPE A

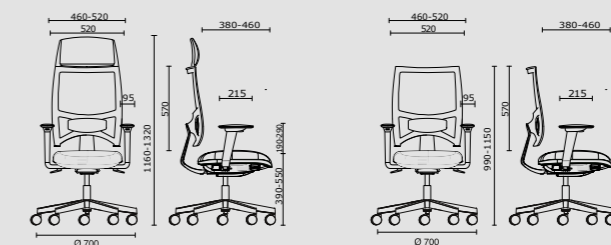

EN-1335-1:2020
TYPE AX

Sitland spa

via Cà Silvestre 52
36024 Nanto, Vicenza - Italia
t +39 0444 637 100
info@sitland.com
www.sitland.com

follow us on

facebook@sitland.official
instagram@sitland.official

Team Strike



An aid to movement, with a synchronised system of adjustment of the angle between seat and back, with a selection of five positions and anti-shock system. Team Strike is a seat that can be adjusted as required. Designed to reduce muscle fatigue and ensure correct posture, it also has adjustable lower back support, a breathable back and shape-retaining upholstered seat with Comfort-Air technology.

Projects

- Paul's Barkleys**, London, United Kingdom (2011)
- ABI**, Milano, Italy (2011)
- Tinkoff Credit System**, Mosca, Russia (2012)
- Epsilon**, Parigi, France (2017)
- Ernst&Young**, Warszawa, Poland (2011)
- London & Partners**, London, United Kingdom (2015)
- Bane Nor**, Oslo, Norway (2019)
- Groupe PSA**, Ta'Xbiex, Malta (2019)
- Aptic**, Sweden, Sweden (2022)
- Cellnex**, Sweden, Sweden (2022)
- Team Olivia**, Sweden, Sweden (2022)

Refin Studio, Milan, Italy (2023)

Models

Executive

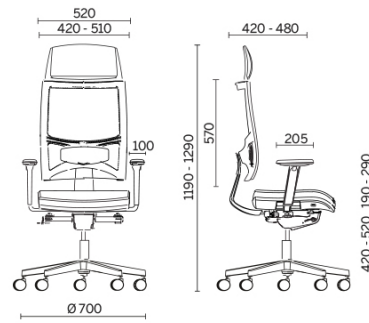

Manager

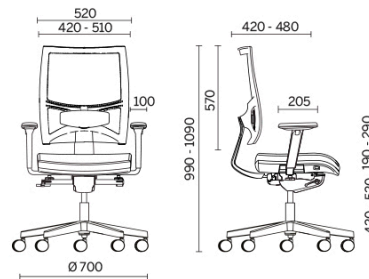

Materials and colours

Seat Upholstery

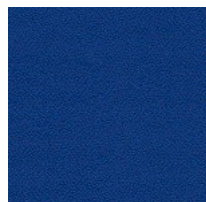

Fabric AB - Xtreme Plus / Camira
Available colours 7



Fabric AL - Alba / FiDiVi
Available colours 6



Fabric BN - Bondai / FiDiVi
Available colours 9

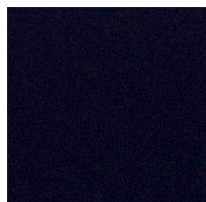

Fabric IP - Ipanema D / Pugi
Available colours 11

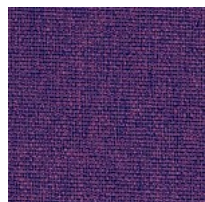

Fabric ME - Medley / Gabriel
Available colours 13

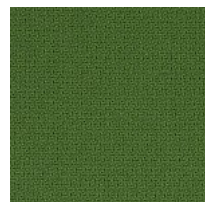

Fabric ST - Step / Gabriel
Available colours 7



Fabric SY - Sinergy / Camira
Available colours 6

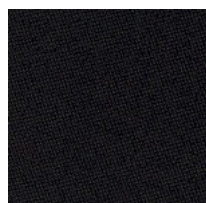

Fabric CH - Chili / Gabriel
Available colours 13

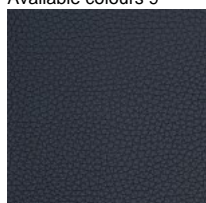

Coated fabric NX
Available colours 11

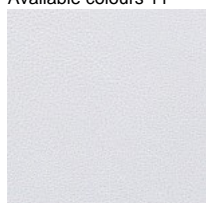

Coated fabric SC - Secret / Flukso
Available colours 12

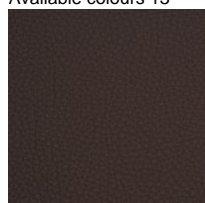

Coated fabric NX
Available colours 1



Leather SX + Coated fabric NX
Available colours 12

Back Upholstery

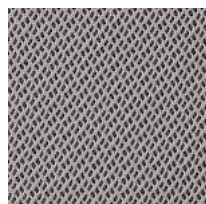

Mesh RY - Rhythm / Gabriel
Available colours 6

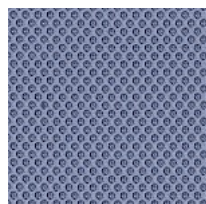

Mesh RR - Runner / Gabriel
Available colours 12

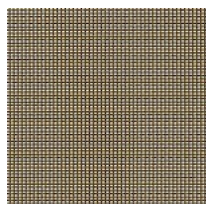

Mesh RP - Net Medium / Plastitex
Available colours 5



Mesh RF - Polo / FiDiVi Service
Available colours 5

Questo prodotto è garantito 5 anni. Sitland Spa si riserva di apportare modifiche e/o migliorie di carattere tecnico ed estetico ai propri modelli e prodotti in qualsiasi momento e senza preavviso. Le foto e i colori visualizzati sono puramente indicativi e possono variare rispetto alla realtà. Per maggiori informazioni si prega di contattare il nostro Servizio Clienti service@sitland.com