

Tavoli scrivania L 180 con mobile di servizio P 66 (Dx o Sx)/Desks W 180 with service unit D 66 (R or L)

P 180 x H 75	P 180 x H 74	P 180 x H 75	P 180 x H 75	<p>Schema delle 3 posizioni di montaggio /Scheme of 3 assembling solutions</p>
902.TM.6_18_ Sx/L - Dx/R	902.TV.6_18_ Sx/L - Dx/R	902.TV.6_18_ Sx/L - Dx/R	902.TM.6_18_ Sx/L - Dx/R	
902.PM.6_18_ Sx/L - Dx/R	902.PV.6_18_ Sx/L - Dx/R	902.PV.6_18_ Sx/L - Dx/R	902.PM.6_18_ Sx/L - Dx/R	

Tavoli scrivania L 200 con mobile di servizio P 66 (Dx o Sx)/Desks W 200 with service unit D 66 (R or L)

P 180 x H 75	P 180 x H 74	P 180 x H 75	P 180 x H 75	<p>Schema delle 3 posizioni di montaggio /Scheme of 3 assembling solutions</p>
902.TM.6_20_ Sx/L - Dx/R	902.TV.6_20_ Sx/L - Dx/R	902.TV.6_20_ Sx/L - Dx/R	902.TM.6_20_ Sx/L - Dx/R	
902.PM.6_20_ Sx/L - Dx/R	902.PV.6_20_ Sx/L - Dx/R	902.PV.6_20_ Sx/L - Dx/R	902.PM.6_20_ Sx/L - Dx/R	

Tavoli scrivania L 180 con mobile di servizio P 92,5 (Dx o Sx)/Desks W 180 with service unit D 92,5 (R or L)

P 180 x H 75	P 180 x H 74	P 180 x H 75	P 180 x H 75	<p>Schema delle 3 posizioni di montaggio /Scheme of 3 assembling solutions</p>
902.TM.9_18_ Sx/L - Dx/R	902.TV.9_18_ Sx/L - Dx/R	902.TV.9_18_ Sx/L - Dx/R	902.TM.9_18_ Sx/L - Dx/R	
902.PM.9_18_ Sx/L - Dx/R	902.PV.9_18_ Sx/L - Dx/R	902.PV.9_18_ Sx/L - Dx/R	902.PM.9_18_ Sx/L - Dx/R	

Tavoli scrivania L 200 con mobile di servizio P 92,5 (Dx o Sx)/Desks W 200 with service unit D 92,5 (R or L)

P 180 x H 75	P 180 x H 74	P 180 x H 75	P 180 x H 75	<p>Schema delle 3 posizioni di montaggio /Scheme of 3 assembling solutions</p>
902.TM.9_20_ Sx/L - Dx/R	902.TV.9_20_ Sx/L - Dx/R	902.TV.9_20_ Sx/L - Dx/R	902.TM.9_20_ Sx/L - Dx/R	
902.PM.9_20_ Sx/L - Dx/R	902.PV.9_20_ Sx/L - Dx/R	902.PV.9_20_ Sx/L - Dx/R	902.PM.9_20_ Sx/L - Dx/R	

Note:

① Le finiture gres e cuoio non sono in pronta consegna. Per la disponibilità contattare l'ufficio commerciale/ Porcelain stoneware and leather finishes are not in prompt delivery. Please contact the commercial department to check availability;

② I tavoli possono essere montati sui mobili di servizio (destri o sinistri) scegliendo tra 3 diverse posizioni. Per ogni soluzione compositiva è disponibile la dimensione del corrispondente modesty panel (vedi relativa quota indicata con MP) mentre il canale passacavi si ordina secondo la lunghezza del piano di lavoro utilizzato/ The desks can be mounted on service units (right or left hand) in 3 different positions. Find the proper modesty panel to match the chosen composition (see sizes indicated with MP), while the cable channels change according to the size of the worktop;

③ Le dimensioni sono espresse in cm - consultare il listino prezzi per le caratteristiche tecniche, i codici degli articoli e delle finiture/ Dimensions are stated in cm - for technical characteristics, article code numbers and finishing see price list;

■ Prodotti non in pronta consegna. Per la disponibilità contattare l'ufficio commerciale/ Items not in prompt delivery. Please contact the commercial department to check availability;

Ⓞ Articolo subordinato a commessa minima. Previsto anche nella versione con fori e tappi passacavi (Optional - Vedere listino) /Item tied-up to a minimum quantity production. Also forseen in a version including holes and out-let lids. (Optional - Refer to price list);

V Vetro/Glass; C Cuoio/Leather; G Gres/Gres.

## Tavoli per composizioni/Desks for compositions

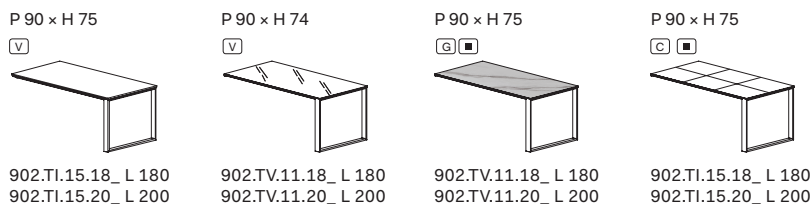

## Tavoli riunione/Meeting tables

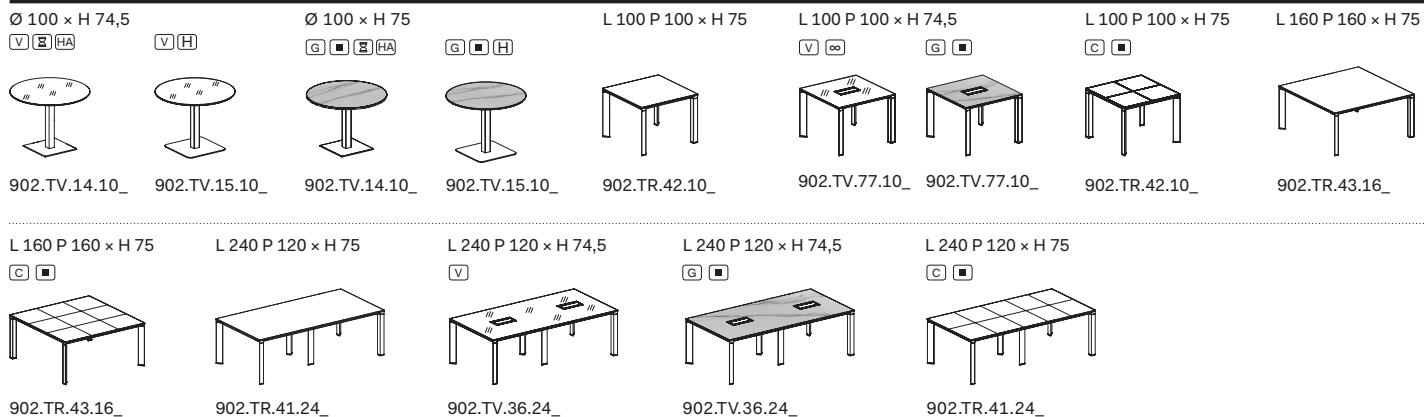

## Tavoli riunione componibili con gambe centrali rientrate/Modular meeting tables with central recessed legs



## Elementi per tavoli riunioni componibili con gambe centrali rientrate/Modular elements for compound meeting tables with central recessed legs

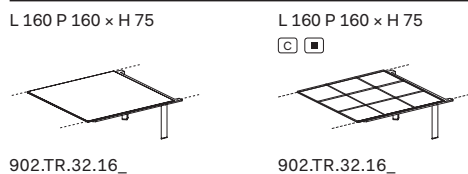

## Modesty panel – canalizzazione per tavoli scrivanie su mobili di servizio/Modesty panel – wire management for desks on service units

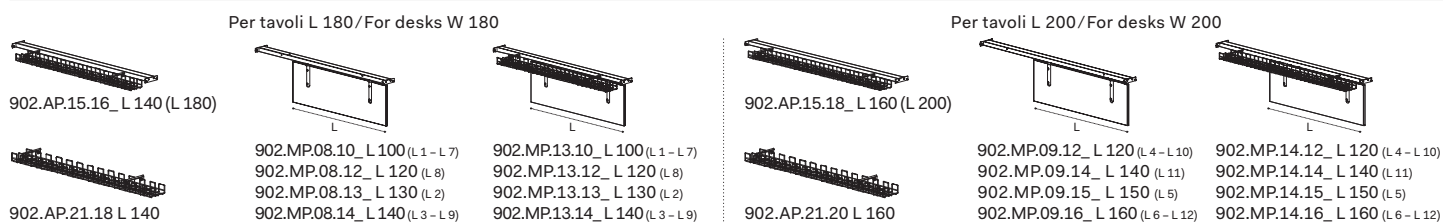

## Modesty panel in cuoio /Leather modesty panel

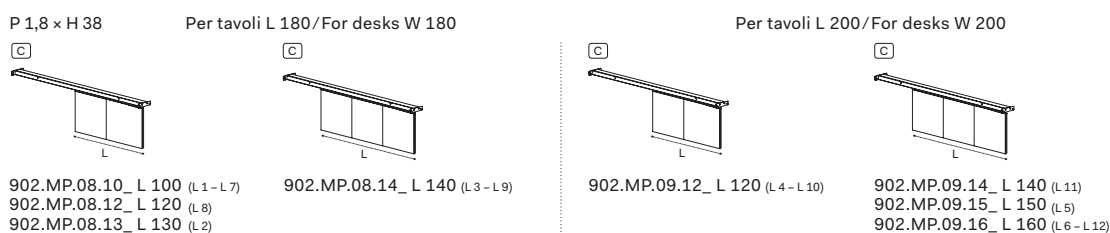

## Accessori /Accessories

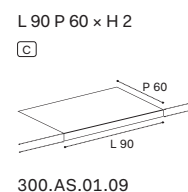

## Canalizzazione per tavoli scrivanie/Wire management for desks

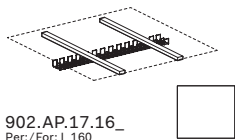

902.AP.17.16\_  
Per./For: L 160

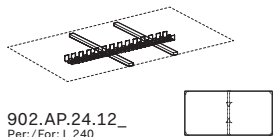

902.AP.24.12\_  
Per./For: L 240

## Cassettiere/Pedestals

L 42 P 57 x H 55,5



550.CS.10.04\_  
Melaminico/Melamine

550.CS.20.04\_  
Melaminico/Melamine

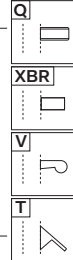

L 32,2 P 54,2 x H 55,6



550.CS.1M.03\_  
Metalliche/Metallic

550.CS.2M.03\_  
Metalliche/Metallic

L 42,2 P 54,2 x H 55,6



550.CS.1M.04\_  
Metalliche/Metallic  
Vaschetta porta  
cancelleria inclusa  
/Stationery tray included

550.CS.2M.04\_  
Metalliche/Metallic

## Mobili di servizio e cassetteria interna /Service unit and internal pedestals

L 180 P 66 x H 63

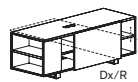

902.MS.6\_-18\_  
Sx/L - Dx/R  
Indipendenti e per integrazione  
/Independent and for integration

L 180 P 92,5 x H 63

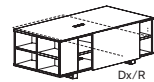

902.MS.9\_-18\_  
Sx/L - Dx/R  
Indipendenti e per integrazione  
/Independent and for integration

L 42 P 55 x H 48



550.CM.01.04\_

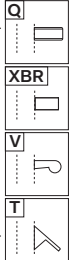

**Note:** Per portacancelleria cassetti, vedi capitolo DV300-Accessori/For stationary tray, see chapter DV300-Accessories.

**Note:** La finitura nero opaco non è in pronta consegna, per la disponibilità contattare l'ufficio commerciale.  
/Matt black finishes is not in prompt delivery. Please contact the commercial department to check availability.

## Accessori per canalizzazione - Elettificazione - Vari/Accessories for wire management - Electrification - Various

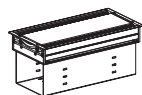

300.AC.26.02 L 24,5  
300.AC.26.03 L 34,5  
300.AC.26.04 L 44,5



300.AC.20.02\_ L 24,5  
300.AC.20.03\_ L 34,5  
300.AC.20.04\_ L 44,5

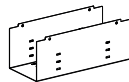

300.AC.25.02 L 23,5  
300.AC.25.03 L 33,5  
300.AC.25.04 L 43,5  
Marsupio/Basket



300.AP.S1.02 L 20,5  
300.AP.S1.03 L 30  
300.AP.S1.04 L 42  
Per./For top access 300.AC.26\_

L 32 x P 12,3



300.AC.38.02\_ H 2,4

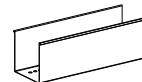

300.AC.67.03  
Marsupio per top access  
300.AC.38.02  
/Basket for top access  
300.AC.38.02



300.AT.A6.02 L 21  
300.AT.A6.03 L 25,5  
300.AT.A6.04 L 39

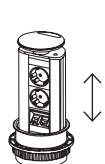

300.AP.T4.01  
300.AP.T5.01 - UK  
300.AP.T6.01 - US



300.AP.T8.11  
300.AP.T8.14  
300.AP.T8.17  
300.AP.T8.20



300.AP.T2.01 Ø 8



300.AP.T7.01 Ø 6  
300.AP.T8.01 Ø 8



300.AP.V2.15



300.AP.V1.00

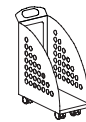

300.AC.06.05\_

## Bracci porta video/Arms for video support

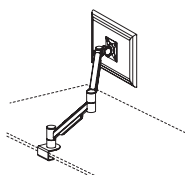

300.AC.02.01  
Braccio porta video mobile su piano  
/Dynamic arm for video support on  
deskbase

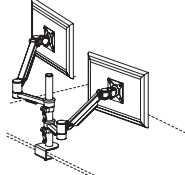

300.AC.02.02  
Doppio braccio porta video mobile  
su piano/2 dynamic arms for video  
support on deskbase

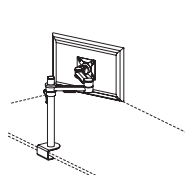

300.AC.01.01  
Braccio porta video statico  
su palo/Static arm for video  
support on pole

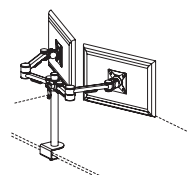

300.AC.01.02  
Doppio braccio porta video statico  
su palo/2 Static arms for video  
support on pole

### Note:

1 Le finiture gres e cuoio non sono in prontaconsegna. Per la disponibilità contattare l'ufficio commerciale/Porcelain stoneware and leather finishes are not in prompt delivery. Please contact the commercial department to check availability;

2 Per la scelta dei contenitori e degli accessori vari, consultare il relativo listino o catalogo/To choose storage units and accessories, please check correspondent price list or catalogue;

3 Le dimensioni sono espresse in cm - consultare il listino prezzi per le caratteristiche tecniche, i codici degli articoli e delle finiture/Dimensions are stated in cm - for technical characteristics, article code numbers and finishing see price list;

■ Prodotti non in pronta consegna. Per la disponibilità contattare l'ufficio commerciale/Items not in prompt delivery. Please contact the commercial department to check availability;

□ Articoli prodotti solo su richiesta/Items produced only on demand;

HA Gambone in alluminio anodizzato / Metal column made in "Anodized" aluminium;

H Gambone verniciato a polveri in bianco, alluminio o antracite / Metal column electrostatic painted in white, aluminum or anthracite;

G Gres/Gres;

C Cuoio/Leather;

V Vetro/Glass;

☑ Con serratura/With lock;